

Kewaskum Statesman

"Gateway to the Kettle Moraine State Forest"

Volume 82

Kewaskum, Wisconsin Friday, February 3, 1978

Number 6

Week's Wit

"Chickens are the most useful animal," wrote little Tami in her essay. "You can eat them before and after they are born."

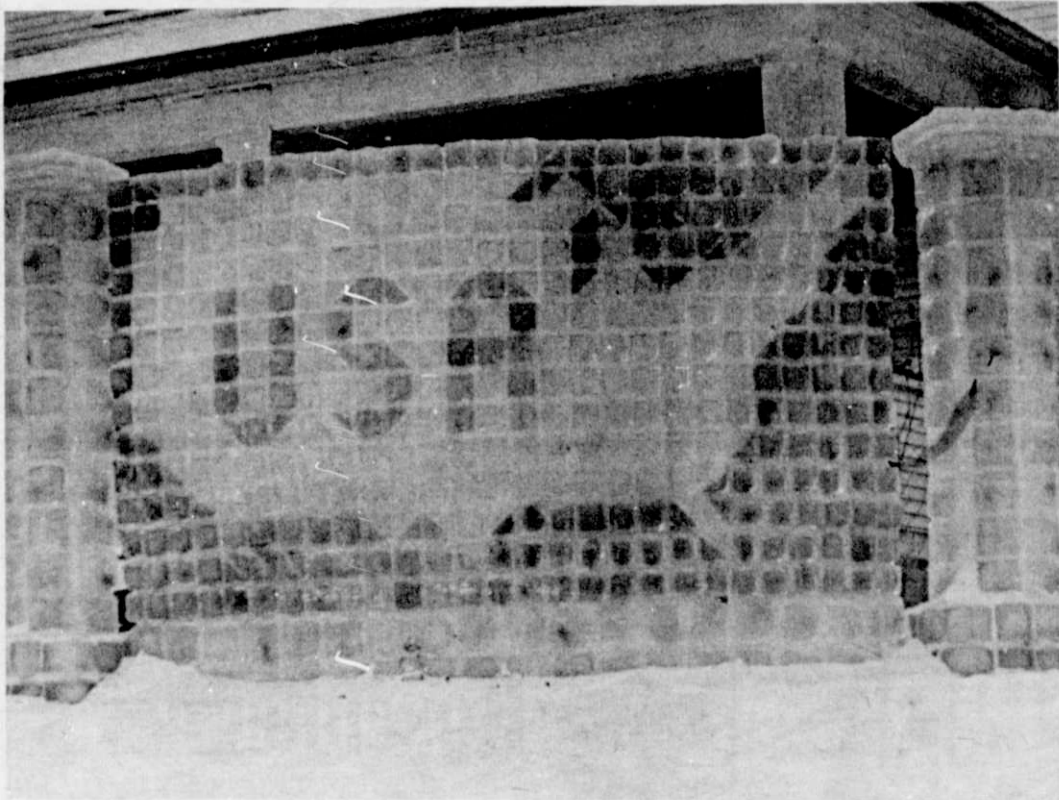

ICE SCULPTURE—Kewaskum artist Dan Meilahn recently completed his annual ice sculpture in front of his home on U. S. Hwy. 45 near the south village limits. Near-

ly 600 blocks of ice were used to build the 10 feet wide and 6 feet high construction in red, white and blue colors. Last year Meilahn built a similar ice sculpture on King

Tut. In 1976 he iced a huge American flag to commemorate the Bicentennial. The inclusion of Roman-style columns flank the sculpture.

(Statesman photo by David Schoofs)

Busing Policy Concerning Pickup Points Discussed by School Board

By MARYANNE MERWIN
Statesman Staff Writer

When the Transportation Committee of the Kewaskum Board of Education meets to discuss "pick-up points and walking distances" there will have been a change in the membership of that group.

Richard Theusch asked to be excused from the duties of that committee Monday night after considerable discussion concerning present board policy regarding walking distances. Theusch reported that he'd received a request from a parent recently for a child to be picked up at home for medical reasons. At this point he expressed concern over deviating from past board policy saying that until an official policy change would be made, the board could be charged with not being fair to all the children of the district. Charles Ogi said the medical excuse would have to be presented before any busing changes could be made in this specific case.

Superintendent Floyd Brenholt said that medical excuses have always been honored in the past when authorized by a physician. But he did ask: "What is the Board's policy going to be if not one-half mile?" No specific answer could be given, though several alternatives were discussed, because the number of extra miles and possible rerouting of buses — if any — could not be determined without further study of the situation.

Parents from the Lake Seven/Beechwood area in attendance Monday had been asking that their children be picked up at their driveways instead of walking to a pick-up point during the winter months. They said that no changes in routing have ever occurred to allow their children to be picked up at home, and said they believed they were the only ones on that route who's children were walking to a pick-up point during the winter. They stressed that there would be no difficulty for the route driver in being able to turn around and no significant amount of mileage involved.

John Tessar will replace Theusch on the Transportation Committee which expects to meet soon to discuss the question.

Jean Goeden distributed an outline explaining some definitions that will guide the Values Education Subcommittee of the Curriculum Committee.

A teacher from Menomonee Falls, Peter Vickman, will be added to the Drivers' Education team at Kewaskum. Certified and licensed in that ar-

ea, Vickman will instruct Saturdays and after 5 p. m.

Two programs not involving the use of local funds were approved unanimously by the board. Project money from Title IV-B will provide film, projectors and filmstrips for Kewaskum children through the elementary grades and library services, while high school students studying general math and having problems with that subject will get a boost through some computer programs. Holy Trinity School will be using their allotted

(Continued on Page 2)

Ray Skrentny, Druggist Here 31 Years Dies

Raymond F. Skrentny, 73, of 104 Main St., Kewaskum, passed away Thursday, Jan. 26, at his residence. He was owner and pharmacist of the former Corner Drug Store in Kewaskum for 31 years.

He was born Dec. 14, 1904, in Milwaukee, and married Ann Felden on Oct. 29, 1934, in Indianapolis, Ind. They moved to Kewaskum in April of 1946.

He was a charter member of the Kiwanis Club of Kewaskum.

Survivors include his wife; six sons, Raymond Jr. of Kewaskum, Barney (Julia) of London, England, Thomas (Bonnie) of Sun Prairie, and Robert (Sandra), David (Claudia) and Jerome (Germaine), all of West Bend; ten grandchildren; two brothers, Ervin (Irene) and Frank, both of Milwaukee; two sisters, Phyllis Potmagorsky of Milwaukee and Clara (Al) Dettlaff of Cudahy, and other relatives and friends.

Private funeral services were held Sunday at the Fenig Funeral Home, Milwaukee. Burial was in St. Adalbert's Cemetery, Milwaukee.

The family prefers memorials to Holy Trinity Church, Kewaskum.

Blood Bank Here Feb. 28

Area donors are asked to mark their calendars for Tuesday, Feb. 28, as the date for the spring (?) blood drive.

The Kewaskum High School will again be the site with the hours being 1:30 - 6:30 p. m. Donors will NOT be called but postcards will be sent to all past donors.

New donors are also welcome. Call 626-2210 for more information.

YOU WEREN'T THE ONLY ONE WITH PROBLEMS

Getting a Paper Out in a Blizzard

Everything was fine last last Wednesday evening as our paper was all ready for the press at our central printing plant in Plymouth Thursday morning.

On Thursday morning we couldn't get out of the driveway with five foot snowdrifts in front of the garage door.

Later in the day our telephone went dead and we couldn't call out or receive calls. We were sort of isolated. Friday morning we had to struggle over the snowdrifts to make calls from a neighbor's house.

Finally we got the driveway plowed out about 11:30 a. m. Friday. Then the car wouldn't start. Our daughter tried to help and we pinched her fingers twice slamming down the hood. Then her car wouldn't start either.

So we hired a four-wheel drive to make the hazardous trip through the snowbanks to Plymouth to have our papers printed. It got only as far as St. Michaels when the road was impassable. So back to Kettle Moraine Drive, then a round-about route to H, to 144, to Random Lake, to 57, and finally into the back door of Plymouth.

There was some trouble with the press and we were short of papers.

Trying another route home the four-wheel became stuck in a snowbank and it took a half hour of shoveling to get it out. Nearing home on 45 the vehicle had a blowout with no spare tire and had to

be driven flat until a phone could be reached. Then we took a car out to pick up the papers from the four-wheel and bring them in.

The costly trip to Plymouth took five hours, from before noon until 5 p. m.

Hope you enjoyed your late paper. It didn't make much difference, the carriers couldn't get out anyway.

Plows, Snowmobile Help Rescue Squad

During last Thursday's blizzard, it took at least three snowplows to get a Kewaskum ambulance to a woman on State Hwy. 28 west of the village.

According to County Highway Commissioner Frank Scharrer, a patrol truck led the ambulance and became stuck behind a stranded car. A larger V-plow was unable to get around the two blocked vehicles. Finally a second V-plow was able to get through from the north, and the rescue squad transported the woman to St. Joseph's Community Hospital, West Bend.

In another Kewaskum rescue squad call during the storm which continued on Friday, the ambulance was delayed for about two hours until a snowplow could clear the way. Finally a snowmobile was put into use to get the patient to the waiting ambulance.

County plows also assisted in other emergency requests.

Registration Feb. 7 - 8 for Kindergarten

This year's annual "round-up" for the parents of all prospective kindergarten pupils in the Kewaskum school district will be held during the day on Tuesday, Feb. 7, and Wednesday, Feb. 8, from 9:00 a. m. to 12:00 noon, and 1:00 to 3:00 p. m. in the Beechwood, Farmington, Kewaskum and Wayne school offices. Please register your child at the school in your area on one of the above days. It is not necessary to bring the child while registering.

To be eligible for enrollment in kindergarten, children must have attained their fifth birthday on or before Dec. 1, 1978. Evidence of date of birth, either a birth certificate or a baptismal certificate, must be brought to the office at the time of enrolling.

Parents of bus pupils will need their section number and fire number as well and also fill out busing forms.

Parents will register their children for next year's term and get the necessary health forms. If you know of any new families in this district, please pass this information on to them.

It is important to register your child on either of these two days so that plans may be made for them and staff requirements for next year are known.

School Board

(Continued from Page 1)

funds for textbooks.

The second program involves the application for two full-time substitute teachers through CETA. The merits of having a regular substitute at the high school level were presented by Clark Pearson in such a convincing manner that John Tessar suggested Kewaskum try to obtain one for the elementary schools as well. Although Kewaskum is eligible, there may not be enough of these teachers available at this time through this program.

Fairmont Foods Promotes Beckman To Omaha Plant

W. C. Geisler, Regional General Manager - Omaha Dairy Region, announced the promotion of Dale R. Beckman to the position of Plant and Distribution Manager - Omaha Ice Cream Plant - Omaha Dairy Region, effective upon the completion of his assignments at Kewaskum.

Dale joined Fairmont in March 1974, as Ice Cream Supervisor at Moorhead, Minn. In September 1975, he was promoted to Plant Manager at Kewaskum, and has held that position until the present time. His previous background includes over 15 years experience in the Food and Dairy Industries. He has held production management positions with Gillette and Alamito Dairies, both of Nebraska, and has also served as a Sales and Service Representative with the International Paper and Bonewitz Chemical Companies.

Dale received his B.S. degree in Dairy Manufacturing from the University of Nebraska at Lincoln.

At the present time, Dale is still working in Kewaskum but he and his wife, Dorothy, have moved from West Bend to Omaha.



JOHN BORAY, R. Ph.

When giving medicine: Read the label and instructions beforehand. Never give medicine from an unlabeled bottle. Before measuring liquid medicine shake the bottle thoroughly each time. Don't give medicine in the dark; you may have picked up the wrong bottle.

We welcome your pharmacy business

Kennelly Pharmacy

Fire Department Raises \$42.10 for MD

The Kewaskum Fire Department's campaign for Muscular Dystrophy raised \$42.10, it was announced by Bruce Petri, local chairman.

This was the department's tenth year that they have helped. Petri thanked all those who helped, the volunteers who distributed the canisters, the merchants who displayed them, and the many contributors.

The money collected will be used for wheelchairs, braces, other orthopedic equipment, physical therapy and summer camp for persons suffering from 35 different types of neuromuscular diseases in Washington county and for the world wide research.

MPTI OFFERING SPECIAL COURSES AT SCHOOL

MPTI is offering a special course entitled "Understanding the Psychological Needs of the Aged." The program is set for Tuesday evening, Feb. 7, and 14, from 6:30 to 9:10 p. m. at the Kewaskum High School.

Also a three-evening course will be offered on "Microwave Cooking" as soon as there are ten or more interested people.

Please call Roy Esser at 626-2166 to register or for more information.

Jr. Woman's Club To Meet Thursday

The Kewaskum Junior Woman's Club will hold its regular monthly meeting at the Valley Bank on Thursday

Feb. 9, at 8:00 p. m.

The Youth Runaway Program will be presented by the Youth Service Bureau of Washington County. There will be a panel discussion, as well as a film strip entitled, "Walkin's Too Slow."

Hostesses for the evening will be Mrs. Wendy Coulter,

Page 2
Kewaskum Statesman
Friday, February 3, 1978

Mrs. Ann Fee, Mrs. Shirley Perkins, and Mrs. Char Keller.

Guests for the evening will be the senior girls.

CARPET — UPHOLSTERY Cleaning Service

Professional
Deep Steam* Extraction
No Soap Residue, Fast Drying
Safe and Gentle for All Fibers
Ask About Our
Carpet Protection Treatment
FREE ESTIMATES
Residential - Commercial
Call 338-0783 Anytime



Syl's Carpet & Upholstery Cleaning Svc.

DOLLAR DAYS SAVINGS



RC or Diet Rite Cola 8 pk. 16 oz. Bottles **99¢**

64 oz. COKE **49c**
Returnable Bottle

Thielman SUMMER SAUSAGE 12 oz. Size **\$1.39 each**

Fairmont 2% MILK **\$1.25 gal.**

Golden Valley GOLD CORN SWEET PEAS **5 \$1**
16 oz. Cans
SAVE... BUY THE CASE 24 - 16 oz. Cans **\$4.69**

CREAMETTES EGG NOODLES Assorted Widths 16 oz. Pkg. **49c**

Assorted Chocolate Covered BRACH'S CANDY 12 oz. Box **99c**

CAMPBELL'S CHICKEN SOUP 4 10 1/2 oz. Cans **88c**
FRANK'S KRAUT Made From Quality Cabbage 3 27 oz. Cans **\$1**
PHILADELPHIA Cream Cheese 8 oz. Pkg. **52c**
SHORTENING Cream White 3 lb. Can **\$1.39**

Chunk or Hi-Protein TUFFY DOG FOOD 50 lb. Bag **\$6.49**

Our Family Applesauce 50 oz. Jar **98c**

SAVE **72c** With This Coupon

Reg. Drip, Elec. Perk HILLS BROS. COFFEE 2 lb. Can **\$5.99** With Coupon
Offer good thru Sat. Feb. 3 L. Rosenheimer Limit, please, 1 per family.

SAVE **15c** With This Coupon

Complete AUNT JEMIMA PANCAKE MIX 2 lb. Box **73c** With Coupon
Offer good thru Sat. Feb. 3 L. Rosenheimer Limit, please, 1 per family.

SAVE **10c** With This Coupon

Post COUNTRY CRISP 15 oz. Box **77c** With Coupon
Offer good thru Sat. Feb. 3 L. Rosenheimer Limit, please, 1 per family.

Cents-ible Savings On Our Fresh Produce!

Red Delicious APPLES 3 lbs. **99c**

GRAPEFRUIT **10/89c**

CELERY 33c bunch

BANANAS 18c lb.

Mrs. Melvin (Pat) Schaub, Others Die

Elsie Schaub, 75, of Kewaskum passed away Sunday, Jan. 29, at St. Joseph's Community Hospital, West Bend, where she had been a patient for the past four weeks.

She was born March 10, 1902 in the Town of Kewaskum to the late William and Bertha Marth Dobke. On June 12, 1926 she married Melvin (Pat) Schaub in St. Lucas Lutheran Church, Kewaskum. They farmed in the Town of Kewaskum until 1951 when they moved to the Village of Kewaskum.

Survivors include her husband; two sons, Leland (Darlene) and Lester (La Verne) both of rural Kewaskum; nine grandchildren; four great-grandchildren; one brother Edward Dobke of Kewaskum; other relatives and friends.

One brother preceded her in death.

She was a member of St. Lucas Church and the XYZ Club of Kewaskum.

Services were held Wednesday at 2 p. m. at St. Lucas Church with Pastor Paul Hoenecke officiating. Burial was in Lutheran Memorial Park.

Visitation was at Miller's Funeral Home after 4 p. m. Tuesday and at the church Wednesday from noon to the time of services.

EDWARD SCHLADWEILER

EDWARD J. SCHLADWEILER of 1013 Lincoln Dr., E., West Bend, died at his residence on Thursday, Jan. 26, at the age of 83.

He was born Dec. 21, 1894, in the Town of Auburn, Fond du Lac Co. At an early age the family moved to the Town of Farmington.

After his marriage to Maria Berres at St. Michael's Church on May 1, 1917, they continued living in the Town of Farmington near St. Michaels until April, 1953, when they moved to West Bend. He has lived there since that time.

Survivors include his wife; four children, Michael (Mildred) of Carlisle, Pa., Sylvester (Doris) of Ashford, Genevieve (Jacob) Wenninger and Angeline Ruplinger, both of West Bend; one daughter-in-law, Katherine Yearling of Kewaskum; 16 grandchildren; 16 great-grandchildren; three sisters-in-law; one brother-in-law, and other relatives and friends.

One son, Urban, a son-in-law, Richard Ruplinger, eight brothers and four sisters have preceded him in death.

He was a member of the Apostolate of Suffering.

Funeral services were Saturday at 10 a. m. at the Schmidt Funeral Home and at 10:30 a. m. at St. Frances Cabrini Church. Fr. Leo Lambert officiated and burial was in Holy Angels Cemetery.

Visitation at the funeral home was after 4 p. m. Friday with the prayer vigil at 8 p. m. Friday.

JENNIE TESCHENDORF

JENNIE TESCHENDORF, nee Backhaus, 77, of Rt. 1, Kewaskum, died unexpectedly Sunday, Jan. 29, at Sheboygan Memorial Hospital.

She was born May 21, 1900, in the Town of Scott, and married Richard Teschendorf at Immanuel Lutheran Church, Town of Scott, on April 24, 1918. He passed away in 1976.

The couple farmed in the Town of Scott their entire married lives.

She was a charter member of the Immanuel Lutheran Church Ladies Aid Society and a member of the Beechwood Senior Citizens and the Farmington Homemakers Club.

Survivors include three sons, Marlin of Madison, Elmer of North Wilbraham, Mass., and Richard, Town of Scott; two daughters, Mrs. LaVerne Foerster of Random Lake and Mrs. Loretta Centgraf of Milwaukee; 21 grandchildren; one great-grandchild; three brothers, Arno of Rudolph, Lorenz of Glenbeulah and Arthur of West Bend; four sisters, Mrs. Marie Capek and Mrs. Ella Klug, both of Milwaukee, Mrs. Leona Seider of Adell and Mrs. Lydia Kaiser of Random Lake.

Funeral services will be Saturday, Feb. 4, at Immanuel Lutheran Church. Rev. Robert Wilcken will officiate and burial will be in the church cemetery.

Visitation at the Wilk Funeral Home, Random Lake, will be from 4 p. m. on

Friday until 10 a. m. Saturday and at the church from noon until time of services.

A memorial fund has been established in Mrs. Teschendorf's name.

MRS. ANNA KETTER

Mrs. Anna F. Ketter, 83, formerly of Campbellsport, died Saturday, Jan. 28, 1978, at Care Center East, Fond du Lac.

Born Feb. 24, 1894, in Fonda, Iowa, she was the daughter of the late Anton and Julia Pfenning Miller. She was married to Peter Ketter on Sept. 1, 1915, and he died June 22, 1953.

Mrs. Ketter was a member of St. Matthew's Catholic Church Christian Mothers and Altar Society.

Surviving are a son, Leo of Campbellsport; four grandchildren; seven great-grandchildren; a brother, Tony Miller of Charles City, Iowa; and a sister, Mrs. Hannah Weasler of Cedar Lake Home, West Bend. Four brothers and a sister preceded her in death.

Funeral services were held at 7 p. m. Tuesday at Twohig Funeral Home, Campbellsport, and at St. Matthew's Church, Campbellsport, at 7:30 p. m. The Rev. Victor Kemmer officiated and burial followed in the parish cemetery.

Visitation for Mrs. Ketter was after 3 p. m. Tuesday at the funeral home.



Holz Member Of 25 Year Club



Howard "Howie" Holz, 629 Arthur Place, West Bend, recently became a member of the Regal Ware, Inc. 25 Year Club.

Beginning at Regal on January 26, 1953, Holz has worked in the Maintenance Department, most recently as a Maintenance Group Leader.

Holz is married and his

Page 3
Kewaskum Statesman
Friday, February 3, 1978

wife, Rose Marie, is employed at Amity Leather Products, West Bend. The couple has two children, Paula and William, both college students.

Holz served with the U. S. Army in the Phillipines during World War II. In his spare time, he enjoys working on small engines and old cars, and is presently busy restoring a 1953 Chevrolet.

Company President, James D. Reigle, presented Holz with a specially engraved wristwatch in honor of his years of service.

Geris

BEAUTY SALON

114 Main St.

Featuring

Helene Curtis UNIPERMS

in Savings & Loan Bldg.

(Rear Entrance)

PHONE 626-4455

Kennelly Pharmacy
YOUR ALL SERVICE PHARMACY

KEWASKUM
102 Main
626-8981

SPECIAL

Photo Enlargement

5x7 89¢ 8x10 1.98

PRICES GOOD FOR MONTH OF FEBRUARY

Dear Relatives and Friends:

The Herriges family invites you to celebrate the 25th Anniversary of Bro. Isidore Herriges as a Capuchin Franciscan.

Sunday, Feb. 5, 1978

Open House 2 to 4 p. m.

St. Michael's Hall
St. Michaels, Wisconsin

a perfect love match



DIAMOND WEDDING SETS



By Feature Ring

BIER'S JEWELRY

626-2777

ILLUSTRATIONS ENLARGED

In 14 Kt. white or yellow gold

Now!

MIDWINTER SALE

Throughout Our Huge Store

GREAT SAVINGS



Where More People
Find What They Want

Miller's

On Hwy. 45 in Kewaskum

Fine Furniture Since 1910

Open Daily to 5:30
Mon. & Fri. to 9 p. m.

FREE DEPENDABLE DELIVERY
AND ROOM PLACEMENT

Dinner to Honor Local Eagle Scouts

Invitations have been sent to young men from Kewaskum who qualified for the Eagle Scout award in the past year for the 1978 Eagle Scout banquet.

The dinner will be held at 4:00 p. m. at the Columbus Club, 2531 No. Richmond St. in Appleton, on Sunday, Feb. 5. The program will feature Bill Curry, offensive line coach of the Green Bay Packers as the guest speaker. Bob Schulze, director of Sports and Promotions at WLUK-TV will serve as Master of Ceremonies at the event which is sponsored by Channel 11.

The Eagle award is the sixth progress award that a Scout earns. The requirements include activity in his Troop and Patrol, Scout spirit, 24 Merit Badges of which

11 are required, serving as a leader of his Troop and to plan, develop, and give leadership to others in an approved service project.

Eagle Scouts from Kewaskum to be honored at the dinner are: Gary Miodzik, 990 Fond du Lac Ave. and Lamont Albers, 340 Clinton St., both of Troop 744.

The Eagle Scout recognition dinner is another service of the Bay-Lakes Council which is funded by allocations from United Ways and by the Annual Friends of Scouting Campaign.

Rescue Squad Calls

Thursday, Jan. 26 — Mary Repousch, 21, 6538 Hwy. 28, Kewaskum, removed to St. Joseph's Community Hospital, West Bend, from her home.

Friday, Jan. 27 — Rudolph Tezdir, 8010 Kettle View Dr., Kewaskum, removed to St. Joseph's Community Hospital from his home with a possible heart attack.

Friday, Jan. 27 — Patrick Braun, 19, R. 3, Kewaskum, removed to St. Joseph's Community Hospital with injuries suffered in an auto accident on Hwy. 28 east.

Saturday, Jan. 28—Nancy Manion, 14, Whitefish Bay, removed to St. Joseph's Community Hospital from Sunburst Ski Hill with an injury suffered in a ski accident.

Sunday, Jan. 29 — David Hebert, 9, 383 Cedar St. Fond du Lac, removed to St. Joseph's Community Hospital with injuries suffered in an auto accident.

Sunday, Jan. 29 — Karen Volm, 13, R. 2, Kewaskum removed to St. Joseph's Community Hospital from Hwy. 28 west with injuries suffered in an auto accident.

Page 4
Kewaskum Statesman
Friday, February 3, 1978

Births

WEAVER — A daughter to James and Debra Weaver, Kewaskum, Saturday, Jan. 28.

SCHNEIDER — A son to David and Renee Schneider, Kewaskum, Sunday, Jan. 29.

SCHLADWEILER — A son to Jerome and Anita Schladweiler, Campbellsport, Monday, Jan. 30.

Hlavaty to Speak To Woman's Club; Note Anniversary

The Kewaskum Woman's Club will meet on Feb. 4, at 2:00 p. m. at the Peace Church lounge. Police Chief Donald Hlavaty will speak on local law enforcement services.

The club entertained their husbands at the annual Founder's Day Banquet on Jan. 14, at the West Bend Country Club. Mrs. Minerva Martin, president, greeted the group and reminded them they were celebrating the 65th anniversary of the Woman's Club in Kewaskum. The decorations were in keeping with this occasion and entertainment was provided by the Half Notes, a barbershop quartet.

The next literary discussion group will meet on Tuesday, Feb. 21, at 9:30 a. m. at the library. Anyone interested is welcome to join in. Please note the books being reviewed are by J. R. R. Tolkien. The reviewer for this discussion will be Mrs. Marlys Ryan.

TOP CASH - GLOVES
FOR DISABLED OR DEAD
COWS OR HORSES
NO CHARGE FOR DEAD
CALVES OR PIGS
When Picked up In Area
Phone Collect Oshkosh 233-1010
**NELSON FARM
SERVICE**

"OLE CROW"

**ANIMAL
SERVICE**
CASH or GLOVES
For Dead and
Down Stock
DIAL TOLL FREE
1-800-242-0389
1-800-242-0343
Prompt 3 Hour Service
UP TO 6c A LB.
for live horses over 900 lbs.
as market allows.

Building A Home?



IF YOU ALREADY OWN THE LOT, YOU
MAY NOT NEED A CASH DOWN PAYMENT.

LET US SHOW YOU WHICH OF OUR LOAN
PLANS WOULD BE BEST FOR YOU.

S
KEWASKUM
SAVINGS

OFFICE OF WEST BEND
SAVINGS & LOAN ASS'N.

114 MAIN STREET
KEWASKUM — PHONE 626-2186



Come To Washington County's Largest Home Lender.



U.S. CHOICE BLADE
Chuck Steak 75¢ Lb.

U.S. CHOICE BONELESS
Beef Stew \$1.29 Lb.

U.S. CHOICE BEEF
Short Ribs 79¢ Lb.

HORMEL
Little Sizzlers. . . . 89¢ 12 Oz. Pkg.

U.S. CHOICE BLADE CUT
Chuck Roast

69¢ Lb.

U.S. CHOICE BONELESS
Chuck Roast . . . \$1.09 Lb.

U.S. CHOICE
Rib Steak \$1.89 Lb.

U.S. CHOICE
Rib Eye Steak . . . \$2.89 Lb.

GRADE A FROZEN 4-6 Lb. Avg.
Stewing Chickens . . . 59¢ Lb.

OSCAR MAYER REGULAR OR BEEF
Wieners. . . . \$1.09 1 Lb. Pkg.

PRICES EFFECTIVE MON., JAN. 30
THRU SUN., FEB. 5, 1978

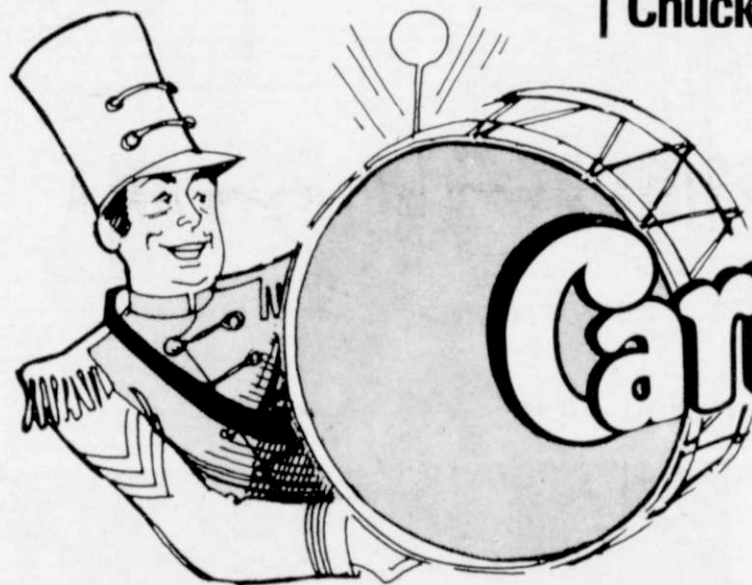

Carnival of Prices!

SAVE 50¢
2 Lb. Can Regular, Drip or Perk-O-Lectric
Butter-Nut Coffee \$6.29
With Coupon
Valid at Sentry Through Feb. 7, 1978.
Limit One Per Adult Cash Value 1/20.
S-39
VALUABLE COUPON

SAVE 29¢
17 Oz. Pkg. Assorted Flavor PEPPERIDGE FARM
Frozen Layer Cake \$1.26
With Coupon
Valid at Sentry Through Feb. 7, 1978.
Limit One Per Adult Cash Value 1/20.
S-41
VALUABLE COUPON

SAVE 13¢
1 Lb. Bowl BLUE BONNET
Soft Margarine 62¢
With Coupon
Valid at Sentry Through Feb. 7, 1978.
Limit One Per Adult Cash Value 1/20.
S-42
VALUABLE COUPON

SAVE 12¢
24 Oz. Bottle
Mrs. Butterworth Syrup \$1.19
With Coupon
Valid at Sentry Through Feb. 7, 1978.
Limit One Per Adult Cash Value 1/20.
S-43
VALUABLE COUPON

SAVE 24¢
Pkg. of 12 Vanilla or Chocolate BORDEN
Ice Cream Sandwiches \$1.25
With Coupon
Valid at Sentry Through Feb. 7, 1978.
Limit One Per Adult Cash Value 1/20.
S-40
VALUABLE COUPON

SAVE 21¢
49 Oz. Box
Cheer Detergent \$1.26
With Coupon
Valid at Sentry Through Feb. 7, 1978.
Limit One Per Adult Cash Value 1/20.
S-44
VALUABLE COUPON

SAVE 10¢
15 Oz. Box
Cheerios Cereal 85¢
With Coupon
Valid at Sentry Through Feb. 7, 1978.
Limit One Per Adult Cash Value 1/20.
S-45
VALUABLE COUPON

SAVE 19¢
SWISS MISS 12 Envelope Pkg. Regular or With Mini-Marshmallows
Instant Cocoa \$1
With Coupon
Valid at Sentry Through Feb. 7, 1978.
Limit One Per Adult Cash Value 1/20.
S-46
VALUABLE COUPON

SAVE 33¢
Bonus Pack of 17 GLAD LARGE
Garbage Bags 82¢
With Coupon
Valid at Sentry Through Feb. 7, 1978.
Limit One Per Adult Cash Value 1/20.
S-47
VALUABLE COUPON

SAVE 13¢
Pkg. of 100 Bathroom Size
Dixie Cup Refill 72¢
With Coupon
Valid at Sentry Through Feb. 7, 1978.
Limit One Per Adult Cash Value 1/20.
S-48
VALUABLE COUPON

SAVE 19¢
On TWO Boxes of 125 Prints or Colors Facial Tissue
Kleenex Boutique 2 for 95¢
With Coupon
Valid at Sentry Through Feb. 7, 1978.
Limit One Per Adult Cash Value 1/20.
S-49
VALUABLE COUPON

SAVE 19¢
On TWO 2 Bar Packs, White or Pink, 6" Off Label Regular Size
Dove Soap 2 for 1.17
With Coupon
Valid at Sentry Through Feb. 7, 1978.
Limit One Per Adult Cash Value 1/20.
S-50
VALUABLE COUPON

SAVE 21¢
10 Oz., 20" Off Label Bottle Regular or Unscented
Wondra Skin Lotion 98¢
With Coupon
Valid at Sentry Through Feb. 7, 1978.
Limit One Per Adult Cash Value 1/20.
S-51
VALUABLE COUPON

SAVE 14¢
Pkg. of 100
Excedrin Tablets \$1.45
With Coupon
Valid at Sentry Through Feb. 7, 1978.
Limit One Per Adult Cash Value 1/20.
S-52
VALUABLE COUPON

SAVE 39¢
Pkg. of 2 Pair, Assorted Colors
No-Nonsense Knee Highs \$1
With Coupon
Valid at Sentry Through Feb. 7, 1978.
Limit One Per Adult Cash Value 1/20.
S-53
VALUABLE COUPON

SAVE 44¢
Case of 6
Duraflame Logs \$5.35
With Coupon
Valid at Sentry Through Feb. 7, 1978.
Limit One Per Adult Cash Value 1/20.
S-54
VALUABLE COUPON

Worst Blizzard in Years Paralyzes Area

What started out as a gentle snowfall Wednesday night developed into the worst blizzard in years Thursday and Friday.

Eight to ten inches of snow which fell whipped into drifts as high as 15 feet by fierce winds which gusted as high as 70 miles per hour. Snowbanks along plowed roads were even higher. Visibility at times was near zero.

Nobody went anywhere. All events were cancelled and many business places closed. Traffic, was at a standstill. Most highways were impassable and closed. Snowplows (all of them that were available) fought a losing battle

against the drifting snow and stalled and abandoned cars on roads and in ditches. The plows were called in Thursday afternoon until a later hour and wreckers could no longer reach the stalled vehicles. Snowmobilers were called on to help some of those snowed in who needed assistance.

Rural residents were isolated and people in town couldn't get out of their driveways. Milk haulers could not reach the farmers and some milk had to be dumped.

When highways were opened over the weekend there was only one lane traffic through many of the huge

drifts and blows continued most of this week opening and widening roads.

Many deaths in the state were attributed to the storm and there were many injuries. Hotels and motels were swamped with stranded people. Grocery store business boomed Saturday as people began to dig out.

The village crew — Augie Schmitt, Al Crickets and Moech — did their usual good job in plowing and clearing efforts. They worked through the night Thursday and were still kept busy all week hauling snow away and widening streets. Some of our readers commented on a job well done.

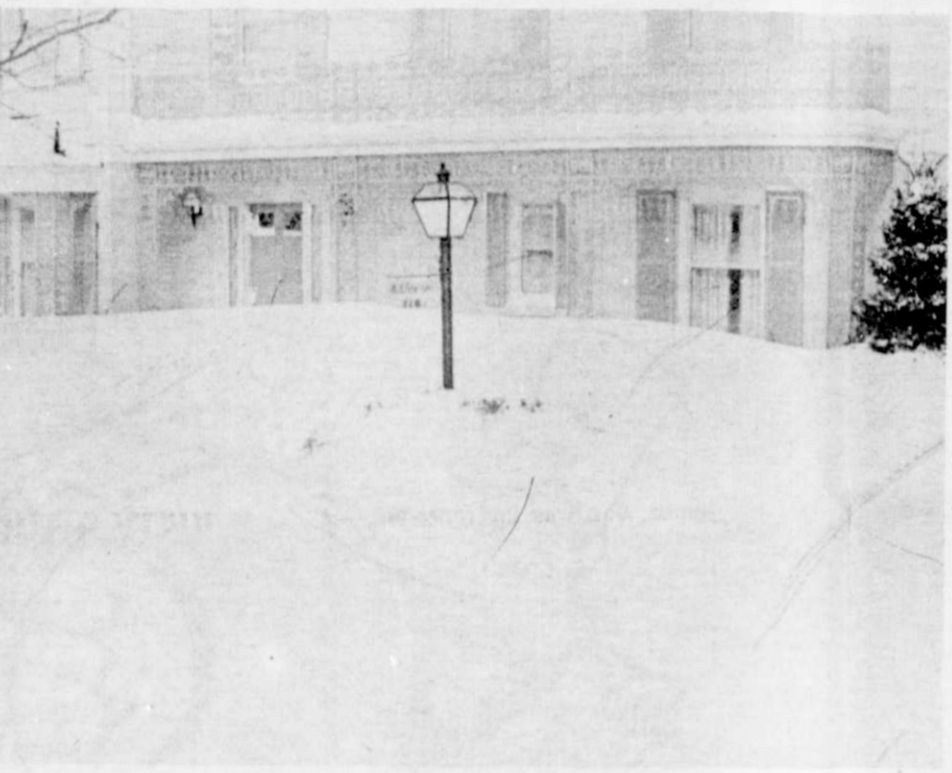

(Statesman photos by David Schoofs)

JOCELYN'S PLASTERAMA
120 Main St. Kewaskum
PHONE 626-4948

Plastercraft Items
Now Holding Classes
Every Wednesday, 7:00 - 9:00 p. m.
STORE Mon., Tues., Thurs. & Sat.—12:00 n - 6:00 p. m.
HOURS Wed., & Fri.—12:00 n - 9:00 p. m.

January Kiwanis Students of the Month

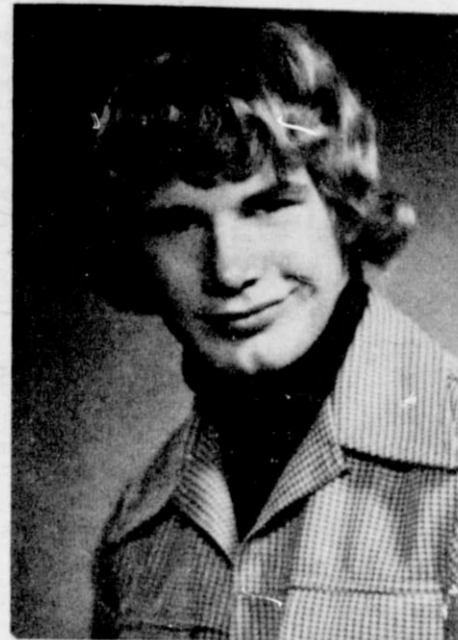

Dan Schmidt

Dan Schmidt, son of Mr. and Mrs. Lewis Schmidt, and Chris Nigh, daughter of Mr. and Mrs. Jerome Nigh, have been selected from the senior class to represent the Kiwanis students for the month of January.

Dan has been active in sports throughout his entire four years at Kewaskum, participating in football, wrestling, track, and baseball. He has been a member of chorus for three years, singing with the swing choir his freshman, sophomore and junior years. Dan had a role in the musical production of "The Music Man" last year and was involved with forensics his sophomore year. As a junior, Dan was the representative for Badger Boy's State. He was a member of student government his freshman and senior years. During his junior year, Dan was on the Prom Court, and a member of the Homecoming Court his senior year.

Chris Nigh was a member of GAA her freshman and sophomore years. As a freshman, she was also a member of FHA and FBLA. Chris has been on the golf team for 4



Chris Nigh

years and selected as M. V. P. for the past three seasons. She has been involved with AFS since her junior year and has hosted an AFS student in her home for a week. She was the first alternate for Badger Girls State. Chris has been with the annual staff since she was a freshman, and presently serves as editor. Chris participated in choir her sophomore, junior and senior years. Last year she was inducted into the National Honor Society.

DRAWING FOR AFS QUILT AND AFGHAN

The drawing for the hand-made holly hobby quilt and afghan made by the adult AFS Chapter will be held Feb. 6 at the high school. Our AFS student, Kimiko Onuma of Japan, will do the drawing. The public is welcome.

LIVE MUSIC

FRIDAY, FEBRUARY 3
JUSTY & THE KEY BENDERS
Sponsored by St. Bridget's Kirnis

SATURDAY, FEBRUARY 4
RAY DORSCHNER AND THE RAINBOW VALLEY DUTCHMEN
Sponsored by the New Fane Sportsmen Club

Large Hall Available for All Occasions

Brat Fry Every Tuesday Night — 50¢
Starting at 6:00 p. m.

THE AMERAHN
1/2 mile north of Kewaskum on Hwy. 45

The WIGWAM
Kewaskum, Wis.

Phone 626-2901

Open Daily 11:30 a. m.

SHORT ORDER MENU
EXCELLENT DINNERS

ENTERTAINMENT

Friday, Feb. 3
FLY BY NITE
Saturday, Feb. 4
AMBER JACK
Free Beer — 7:30 - 9:30

Wednesday, Feb. 8
SCOTFREE
FREE Beer 7:30-9:30 p. m.

Friday, Feb. 10
SCOTFREE
Saturday, Feb. 11
THE FABULOUS
JOHNNY LESTER

JORDANS' in kewaskum

PHONE 626-4618
Open 11:00 Monday - Friday
Saturday and Sunday 8:00
Cocktail Hours 4 to 6 p. m.
HALL AVAILABLE FOR ALL OCCASIONS



Sat.,
Feb. 4
9-1
Vixen

Tired of scrubbing carpeting? Clean it with Nylac quickly and easily. No machine needed. Miller's Fine Furniture carries Nylac.

SIGN on a lighthouse: "Wanted someone for light house keeping."

Campbelsport Sportsmen Club
17th ANNUAL FISHEREE
SUN., FEB. 5 -- 6:30 a.m. - 4 p.m.
CANCELLATION DATE FEB. 12
LONG LAKE on Hwy. 67 at DUNDEE, WIS.
SKIN DIVERS — 1:00 p. m.
CHECKPOINTS — Mrs. Ed's Resort and Holiday Resort
Hot Lunch Served on Lake Bait Sold on Lake
EVERYBODY WELCOME

SUNDAY BUFFET

SUNDAY, FEBRUARY 5, 1978

Featuring: Cornish Hen and Dressing, Roast Loin of Pork, and Pepper Steak. Of course this includes our very special Sunday Salad Bar and Dessert for

4.95

Wednesday Specials

WEDNESDAY NOON, FEBRUARY 8, 1978

Featuring: A cup of ho-made Potato Soup, Salmon Loaf, Parsley Potatoes, Creamed Peas, Jello Fruit Salad, a warm Dinner Roll and a beverage for

2.50

WEDNESDAY EVENING, FEBRUARY 8

Enjoy a specially prepared Fish Fry Plate, including a cup of Shrimp Bisque Soup, Cole Slaw, Potato Salad or French Fries and Rye Bread for

2.95

How about a Fresh Shrimp Plate? It's a special treat for only

3.95

CAMELOT IS NOW OPEN MONDAY EVENINGS SERVING ALL OF YOUR MENU FAVORITES.

Open Monday's at 4:00 p.m.
Serving from 4:00 p.m. to 8:00 p.m.

CAMELOT COUNTRY CLUB

LIVE ORGAN DINNER MUSIC

NOON 'Til 2 P.M.
and 5 P.M. 'Til 8 P.M.

Hwy. 67 Just One Mile E. of Hwy. 41, Lornira
Phone 269-4331

KEWASKUM STATESMAN
250 Main St. Ph. 626-2626

Published Every Friday
Entered as Second Class
Matter at the Post Office,
Kewaskum, Wisconsin 53040
William J. Harbeck &
Marcella M. Harbeck
Publishers

Subscription Rates:
\$6.00 Per Year in State
\$7.00 Per Year Out of State
Single Copy 15c

Friday, February 3, 1978

active member
WISCONSIN
NEWSPAPER
ASSOCIATION
MEMBER

NATIONAL
NEWSPAPER
Association - Founded 1885

FHA NEWS

The monthly meeting of the Kewaskum Chapter of Future Homemakers was called to order at 3:00 p. m. by President Carol Proeber.

The first item on the agenda was FHA Week which will be from Feb. 5 to 11.

On Monday we will have printed napkins at the lunch line. A bake sale will be held during both lunch periods on Tuesday. Wednesday will be "Red and White Day". Thursday will be "Teacher's Day" and Friday we will sponsor a "Disco Dance" with the FFA after the Slinger basketball game.

We then discussed the FHA Banquet which will be held at the Glacier Inn on Monday, May 8, at 7:00 p. m.

There being no further business, the meeting was ad-

journal at 3:20 p. m.

FHA Reporter,
Barbara Schulz

Page 8
Kewaskum Statesman
Friday, February 3, 1978

RIVERSIDE 4-H CLUB NEWS

The Riverside 4-H Club meeting was called to order on Dec. 7 by President Debbie Fry. We discussed the Music and Drama Festival.

Jenny Lightner, Sue Lemke, Laurie Lemke, Mrs. Lemke and Sue Schmitt played "Carol of the Bells," "We Wish You a Merry Christmas" and "Jolly Old St. Nicholas." Mrs. Santa (Colleen Shaw) and Jingles (Miles Shaw) came and passed out a treat and the Christmas presents. We sang Christmas carols and refreshments were served.

The next meeting will be

held Feb. 1.

Our project meetings were scheduled for these dates:

Cooking — Jan. 28 at Mrs. Schmitt's; Crocheting — Jan. 18 at Mrs. Shaw's; Macrame — Jan. 18 at Mrs. Shaw's; Marianetts — Jan. 15 at Mrs. Roden's; Plants — Jan. 21 at Mrs. Matter's; Music — Jan. 12 at Mrs. Lemke's.

News Reporter,
Sue Schmitt

Upon my face is strongly etched
The tracery of years;
I see each petty jealousy,
And all my selfish fears.

I wonder if my mirror
Would a little kinder be,
If I had thought more of my friends
And a little less of me?

— Reta M. White

SCHULZ
REAL ESTATE CORP.
Brokers — Builders
MONICA SCHULZ, Broker
JAMES SCHULZ, Builder
2395 W. Washington, West Bend
Phone 338-6106

J & J AUTO SERVICE

Complete
Automotive Service

Air Conditioning
Service

Tires

Batteries

Mufflers

Brakes

Major & Minor

Engine Repair

Ignition Repair

FREE Pick-up and
Delivery in Kewaskum Area

— HOURS —

7:30 to 6:00 WEEKDAYS

CLOSED ON SUNDAY

450 E. MAIN, KEWASKUM
PHONE 626-2311

WEST BEND MONUMENT CO.

DIV. OF OZAUKEE MONUMENT WORKS, INC.

208 Island Ave. West Bend, Wis.

- FINEST MATERIALS
- EXPERT WORKMANSHIP
- PERMANENT INSTALLATION
- QUALITY COSTS NO MORE

Monuments of
Character



OPEN DAILY 9 to 5; SAT. 9 to 4
or any time by appointment

Gary Koening, Phone Collect 334-3871



PERSONALIZED SERVICE & GUARANTEED SATISFACTION

- CARPETING •
- SHINY-VINYL •
- DRAPERIES & RODS •
- FREE ESTIMATES •

— HOURS —

Mon. & Fri. 10 - 9
Tues., Wed. & Thur. 10 - 5
Sat. 10 - 3

Or By Appointment

214 MAIN ST.
KEWASKUM, WIS.
Phone 626-2181

The Carrier
heat pump
offers
up to
50% savings
in
electric
heating costs.

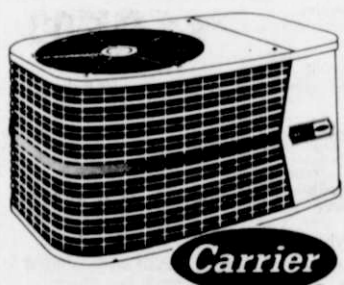

MODEL 38CQ020

Carrier

And gives you summer cooling too!

Extracts heat from outside air instead of producing it by means of flame or resistance elements. Operates for as little as half the cost of resistance heating. No other line of electric heat pumps has so high an average efficiency rating as Carrier. Let us show you how little a Carrier heat pump costs to buy, install, and operate in your home. Phone . . .

Johann, Inc.

• Plumbing • Heating • Air Conditioning •
SALES AND SERVICE

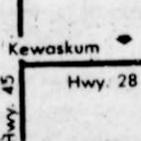

located in St. Michaels, 3 miles east of
Kewaskum on Hwy. 28
Daily 8 - 5:30, Fri. 'til 9, Sat. 'til 1

PHONE
334-9481

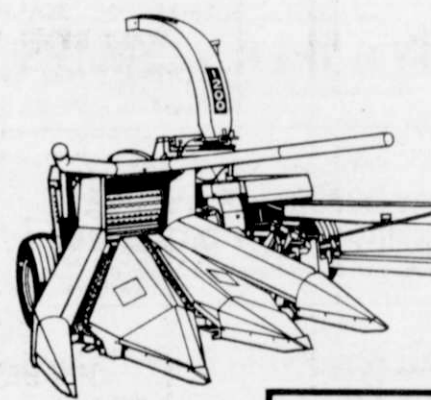
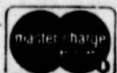

Up to \$225 CASH!

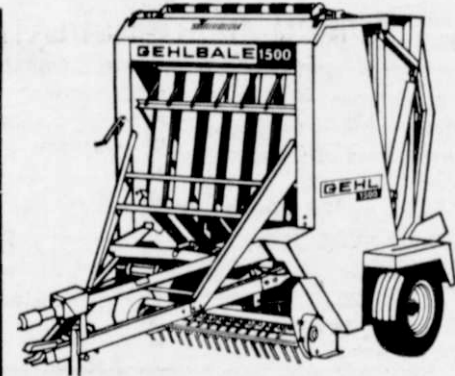

Up to \$180 CASH!

Early Buyer's Cash Bonus

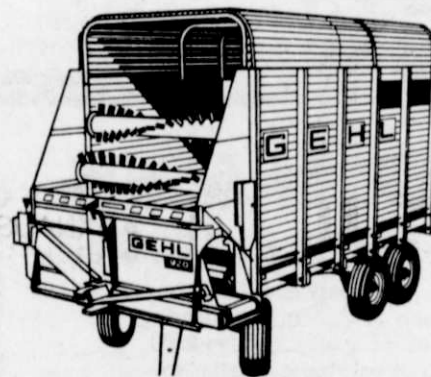

Up to \$80 CASH!

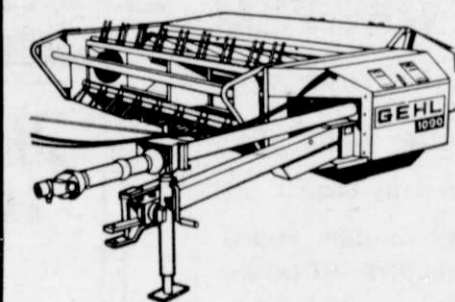

Up to \$125 CASH!

GEHL® Makes Buying Easier

BONUS PAYMENT SCHEDULE

Equipment	Description	Model No.	JAN.	FEB.	MAR.
Forage Harvesters	CB700		\$160	\$130	\$100
	CB800		190	150	115
	CB1200		225	175	130
Mower Conditioners	MC770		\$125	\$100	\$ 70
	MC880		125	100	70
	MC1070		125	100	70
	MC1090		125	100	70
Round Balers	RB1500		\$180	\$140	\$100
	RB1500A		180	140	100
Flat Choppers	FC72C		\$ 80	\$ 65	\$ 50
	FB90		80	65	50
	BU630		80	65	50
	BU640		80	65	50
	BU920		80	65	50

Now you can get cash back from Gehl with the purchase of eligible forage harvesting and haymaking equipment. See us for full details. (Offer valid on eligible equipment retailed between Dec. 19, 1977 and Mar. 31, 1978)

KOHN BROS.
Farm Service, Inc.

626-2707

Schedule for Immunization Clinics Changes

Immunization clinics will be held in West Bend every month beginning Feb. 7. Clinics will be held the first Tuesday of each month from 2:00 - 6:00 p. m. at the Community Health Nursing Service, 515 East Washington St., West Bend.

Immunization clinics are held in Germantown and Hartford in addition to West Bend. The Germantown Clinic is held the second Tuesday of each month at the Germantown Village Hall from 3:00 - 6:00 p. m. The Hartford clinic will be held the third Tuesday of alternating months (February, April, June, August, October, December) at the Recreation Department from 3:00 - 6:00 p. m.

All recommended immunizations are available for children and adults at the immunization sites. Immuniza-

tions for children under seven years of age are provided without charge. Over seven there is a minimal charge depending on immunization given.

For further information call: Community Health Nursing Service, 334-3491 or 644-5204 — Ext. 261.

County Holstein Association Elects

The Board of Directors of the Washington County Holstein Association met recently to elect their officers for the next year.

Dick Mayer of Slinger was elected President of the organization, Mark Pamperin of Allenton was elected Vice President, and Jerry Rogge of Jackson was re-elected as Secretary - Treasurer. Other members of the Board of Directors include Paul Held of Slinger, Mrs. John P. Horlamus of West Bend, Ed Melius of Jackson, and Don Philippi,

Howard Proeber and Hilbert Scheunemann, all of West Bend.

The Washington County Holstein Association plans and sponsors many activities and events for Holstein breeders in Washington County.

Anyone who has an interest in the organization and would like additional information can contact any of the above directors or the Washington County UW-Extension Office.

CAMPBELLSPORT SPORTSMEN'S CLUB Trap Shooting League

January 22

	Won	Lost
Sentry Foods	7	1
King Pin	7	1
Regal Ware	6	2
Glacier I	6	2
Glacier II	6	2
Doyle Const.	4	4
Fuzzy's Tap	4	4
Sno Birds	4	4
Enright's	3	5
Dins Mobil	3	5
B's Hive	3	5
Herriges Oil	2	6
Dundee S. & G.	1	7

Page 9
Kewaskum Statesman
Friday, February 3, 1978

Top Shooters	
Sand Piper Inn	0 8
Bill Prost	23.5
Gary Sena	23.3
Eddie Ebert	23.1
Bruce Survis	23.0
Bill Geidel	22.8
Ralph Bier	22.2
Chuck Doyle	22.2
George Del Ponte	22.1
Stan Priepke	22.1
Kenny Stuart	22.0

slipping up on your
INSURANCE
RESPONSIBILITIES?



Better call your American Family Man. He has the

RESPONSE/ABILITY

for all your family's insurance needs.

**AUTO • HOME • CONTENTS
HEALTH • LIFE**

**AMERICAN FAMILY
INSURANCE**

AMERICAN FAMILY MUTUAL INSURANCE CO.
MADISON, WISCONSIN 53701

Richard C. Gust

156 N. MAIN ST.
WEST BEND, WIS.

Office Phone 338-1313
Residence Phone 626-2765

KitchenAid Dishwashers

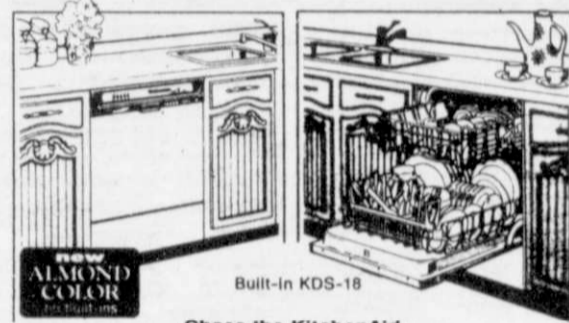

Chose the KitchenAid Load-As-You-Like dishwasher that's right for you.

JOHANN, INC.

• Plumbing • Heating • Air Conditioning
SALES AND SERVICE

Phone 334-9481

Located in St. Michaels, 3 miles east of Kewaskum on Hwy. 28
Daily 8-5:30; Fri. 'til 9; Sat. 'til 1



MAKE YOUR HOUSE A HAPPY HOME
LET KETTLE MORAINÉ INSULATION

HELP!
SUR COMFORT INSULATION

For side walls and attics
of New and Old Homes.

We have treated and tested insulation to meet the recommended R-30 Value (8" - R-30)

90 DAYS SAME AS CASH

Kettle Moraine Electric

1261 Fond du Lac Ave. - Kewaskum
FOR A FREE ESTIMATE CALL:

KIM RODENORCH Kewaskum 626-3007
HAROLD LINDLEY West Bend 334-3363
CALL US AT THE STORE 626-2083



**FOR A
SOLID
JOB**

loaded with opportunities, check into the opportunities that the United States Air Force offers...opportunities that many young men and women find appealing...opportunities for training at some of the finest technical schools in the nation...to work toward a 2-year associate degree...to pick up that valuable on-the-job experience...to enroll in advanced (off-duty) education programs...to receive a worldwide assignment. There's more.

Find out today about these and the many other opportunities that go with an Air Force job. Contact **TSgt Kenneth Hibdon** Air Force Opportunities 7101 W. Capitol Dr. Milwaukee, Wisc. 53216
Call Collect: 414-461-0800

**AIR
FORCE**
A great way of life.

WEST BEND'S ONLY Discount Tire Store

WAALA'S WAREHOUSE SALE

OUR BEST STEEL RADIAL

ER78x14
FR78x14
GR78x14
FR78x15
GR78x15
HR78x15 (slightly higher)
BLEMS
GR70x15 (Raised white letters)
GR70x15 (Police special)

\$225⁰⁰

Sets of 4
Mounted Free
Plus Tax
and Balance

4 PLY TIRES

E78x14
Poly Whitewalls
G78x14
Poly Whitewalls

\$105⁰⁰

plus tax, mount and balance

G78x15
Polyglass Black
H78x15
Polyglass Black

\$110⁰⁰

L78x15
Polyglass Whitewall

SALE ENDS FEBRUARY 28th, 1978 plus tax, mount and balance

TRY OUR FAST SERVICE & IN STOCK ITEMS

- EXHAUST (Lifetime Mufflers)
- BRAKES (disc and Drum)
- BATTERIES (Goodrich)
- WATER PUMPS (Goodrich)
- STARTERS (Goodrich)
- ALTERNATORS (Goodrich)
- PERFORMANCE TIRES
- WHEELS & MAGS
- CAR STEREOS
- C.B.'s (Hy-Gain)

COMING SOON

Complete Showroom Display of 4x4, Van, Pickup & Car Accessories/Equipment

COUPON SPECIAL

**HUNTER
RAPID WHEEL
BALANCERS**

\$2⁹⁹ WHEEL
With Coupon

**HUNTER
COMPUTERIZED
ALIGNMENT**

\$12⁸⁸ with coupon
\$15.00 WITHOUT COUPON
Truck Alignment Extra

**LUBRICATION
SPECIAL
5 QUARTS OIL
WITH FILTER**

\$8⁸⁸
with coupon

COUPON OFFER EXPIRES FEBRUARY 28, 1978

WAALA'S WHEEL & TIRE SHOP, INC.

West Bend

1707 SCHMIDT RD.

338-0663

Sales Open Monday and Friday Nights



... the other guys

WANT ADS

BABYSITTER WANTED — My home or yours. First shift. References. Ph. 626-4568. 2-3-2p

POTATOES — Call 626-2251 after 5:00 p. m. 2-3-4t

ANTIQUA AUTO SWAP MEET & FLEA MARKET — Sunday, Feb. 5. Car parts and accessories from 1927 to 1965, plus old cars for sale. Cow Palace, Hwy. du Lac Fairgrounds, Hwy. 45 & Martin Road. Open 8 to 4 p. m. Admission 75c. Under 12 free. Ph. 414-725-4231. 1t

PUPPIES FOR SALE — Golden retriever puppies. 4 weeks old. 3 males. AKC registered. 626-4196. 1t

FOR RENT — One bedroom upper flat. Call 626-2473. 1-27-tf

FOR SALE — GE gas clothes dryer. Good condition. Call 533-4054 after 5:00 p. m. 1-27-2p

WANTED TO BUY — Standing timber, with or without land. Call or write us for offers. ALGOMA LUMBER COMPANY, Algoma, Wis. 54201. Phone 414-487-3511. 1-27-6

FOR RENT — Lovely 2 bedroom apartment in Kewaskum. Shag carpet throughout. With appliances. \$170 plus security deposit. Ph. 626-4735. 8-12-tf

HELP WANTED — Secretary, Law Office. Full-time position. Typing and shorthand required. Small office with excellent working conditions. Send resume and salary requirements to P. O. Box 98, Kewaskum. 11-25-tf

TIRES — Get your snow tire deal at Roger's Service. Radial snows in stock. Hwy 45 south, Kewaskum. Ph. 626-2888. 10-7-tf

FOR RENT
Retail store, could be used for many types of business. Main street location. Will remodel to suit tenant. This store has parking in front and back. Large front windows to display merchandise. Village of Kewaskum.
Call Owner
KEWASKUM REALTY
Kewaskum, Wis. 53040
626-4392

FOR SALE
350 Lazy Lane, Kewaskum, is the address of this lovely 3 bedroom home. Well insulated. Well built by a very good West Bend builder. 2 car garage, 70 x 150 ft. lot. This home is complete with floor covering and decorating included.
KEWASKUM REALTY
Kewaskum, Wis. 53040
Phone 338 8500

SNOWPLOWING — Country Aire Repair. Phone 626-2717 or 626-4345. 12-23-tf

POTATOES — Call Paul Pampferin, 629-5267. 11-11-tf

OFFICE OR STORAGE SPACE — Available in Kewaskum. Phone Kewaskum Savings, 626-2186. 11-11-tf

COMPLETE wild bird supplies at Schultz's Greenhouse, Kewaskum. 10-7-tf

HIGHEST PRICES paid for old newspapers, copper, brass, aluminum, lead and batteries. Lynn's Waste Paper Co., 121 Island Ave., West Bend, Wis. 1t

LEN LUTERBACH CONTRACTOR — Mason, cement, carpentry, trenching and bulldozing. Quality work at competitive prices. For free estimate, call 338-3305 or 692-9233 collect. 1t

WANTED — Newcomers to the village of Kewaskum. The "Kewaskum Welcomes You" committee would like to see 626-4732 or 626-4219. 5-13

SERVICES OFFERED — Small engines, motorcycle, snowmobile, lawn and garden equipment and outboard repair. Ked-Web of Lac Kewaskum. 1204 Fond du Lac Ave. Phone 626-4344. 1t

SERVICES OFFERED — Perce tests - septic systems installed - swimming pools - field tiling. Schwartz Trenching. Phone Arnold 334-5004 or Gary Schwartz 994-4535. 1t

LISTINGS NEEDED
CALL FOR MARKET ESTIMATE.
J-N REALTY
Jerry Nigh, Broker
626-4063

"For all of your Real Estate Buying or Selling needs (homes, farms, vacant land, commercial, investment),
 call **BOB TISCHENDORF** 533-8557
1702 West Washington St., Hwy. 33
West Bend, WI 53095 Phone 1-414-338-6681

BUY and SELL with
BOWE & WENINGER REALTY, INC.
West Bend 334-7841
Norbert Rohlinger, Broker - Sales — Phone 626-2332
ACTION + SATISFACTION

IN MEMORIAM

"LONESOME ME, WITHOUT A MOTHER"

In memory of our mother, Marie Diedrich, who passed away twenty years ago, Feb. 2, 1958:

Alone on earth, with no Mother of mine. Life she gave me, do not waste it with time.

Her life was short, to teach me what I had to know, My lessons I learned, then Mama went home.

Home to HEAVEN, to praise GOD, and to watch over me. Yes, lesson's I learned Mama, but I still miss thee.

Many times have I wished, on your shoulders to cry, You had magic to cure, and my troubles would fly.

Your memories live on, even tho' you're not here, I love you Mama, with this love I have no fear.

Your safely home in Heaven, with GOD and Daddy, You both gave me life, I'll face it without a caddie.

Lonesome me without a Mother? Forgive me Mama, because I have you, I was lonesome today, feeling very blue.

Twenty years ago today, goodbyes you said to all, I love you Mama, with this love I'll stand tall.

Sadly missed by Vernon and Audrey Fierke, and Donald Diedrich.

Page 16
Kewaskum Statesman
Friday, February 3, 1978

A NOTE OF THANKS
I wish to extend my deepest appreciation to all my relatives, neighbors and friends who remembered me with cards, gifts, visits and phone calls while I was a patient at the hospital. Special thanks to Rev. Darrell Joiner.
Calvin Schaub

DUPLEX FOR SALE
To be salvaged or moved from present lot in Kewaskum. Available for inspection at Fairmont Foods, Kewaskum, Wis. Phone 626-2141

Veterinary Services
LARGE & SMALL ANIMALS
WOODVIEW
VETERINARY CLINIC
Drs. Bushard & Thornborrow
North Point Shopping Center
Hwy. 45 N. of West Bend
Phone 338-1838

Under Construction
2 RANCH HOMES
3-bedroom
on 1-acre lots
in the
Town of Wayne
Feb. 1 Occupancy
H. F. K. Ltd. Builders
For Showing Call
David (Norby) Amerling
626-2320

Notice of Public Hearing

Public notice is hereby given that the Village Board of the Village of Kewaskum, Washington County, Wisconsin, will hold a public hearing on the following proposed ordinance which deals with the adjusting of the village's license and permit fees.
February 6, 1978, at 8:00 o'clock P. M. in the Council Room of the Municipal Building, 204 First Street.
William Martin, Clerk

AN ORDINANCE TO REPEAL AND RECREATE SECTIONS 12.01 (7), (8) and (9) OF THE MUNICIPAL CODE OF KEWASKUM, WISCONSIN, AND TO CREATE SECTIONS 12.01 (12) and 12.01 (13) OF THE MUNICIPAL CODE OF KEWASKUM, WISCONSIN, RELATING TO LICENSE AND PERMIT FEES.

THE VILLAGE BOARD OF THE VILLAGE OF KEWASKUM, WASHINGTON COUNTY, WISCONSIN, DO ORDAIN AS FOLLOWS:

Section 1. Section 12.01 (7) of the Municipal Code of Kewaskum, Wisconsin, is repealed and recreated to read as follows:

(7) DANCE PERMIT. \$25.00 per dance.

Section 2. Section 12.01 (8) of the Municipal Code of Kewaskum, Wisconsin, is repealed and recreated to read as follows:

- (a) Class "A" Retailer's License. \$10.00 per year.
- (b) Class "B" Retailer's License. \$100.00.
- (c) Picnic License (special events). \$1.00 per day.
- (d) Wholesaler's License. \$25.00.
- (e) Operator's License. \$5.00.
- (f) Duplicate License. \$5.00 per license.
- (g) Transfer. \$10.00 per transfer.

Section 3. Section 12.01 (9) of the Municipal Code of Kewaskum, Wisconsin, is repealed and recreated to read as follows:

- (9) INTOXICATING LIQUOR LICENSE.
- (a) Class "A" License. \$150.00.
- (b) Class "B" License. \$200.00.
- (c) Pharmacist's Permit. \$10.00.
- (d) Operator's License. \$5.00.
- (e) Duplicate License. \$5.00 per license.
- (f) Transfer. \$10.00 per transfer.

Section 4. Section 12.01 (12) of the Municipal Code of Kewaskum, Wisconsin, is created to read as follows:

(12) SPECIAL ASSESSMENT CERTIFICATE. \$2.00 per certificate.

Section 5. Section 12.01 (13) of the Municipal Code of Kewaskum, Wisconsin, is created to read as follows:

(13) PARK USE FEE - KITCHEN FACILITIES. \$25.00 per day, \$10.00 to be refunded if facilities are properly cleaned up.

School Menus

KEWASKUM COMMUNITY SCHOOLS

Menus for week of Feb. 6 - 10:

Monday — Ham slice, mashed potatoes, kernel corn, juice and harvest cake.

Tuesday — Spaghetti and meat sauce, lettuce salad, dinner rolls and fruit cocktail.

Wednesday — Fish on bun, potato chips, apple sauce, peaches and cookie.

Thursday — Foot long hot dog, German potato salad, cheese sticks, jello, and cup cakes.

Friday — Bowl of soup, fish crackers, relishes, luncheon meat, and pineapple chunks.

Menus are subject to change. Each meal served with bread, butter and/or margarine and milk.

HOLY TRINITY SCHOOL

Menus for week of Feb. 6 - 10:

Monday — Spaghetti and meat sauce, fruit salad, carrot stixs, bread and butter,

cookie, milk.

Tuesday — Hot beef sandwich, yellow beans, onion rings, O'Henry bar, milk.

Ash Wednesday — Cheese pizza, potato stixs, peas, cookie, milk.

Thursday — Beef casserole, green beans, beans in sauce, bread and butter, rice krispie bar, milk.

Friday — Fishwich, buttered carrots, nut cup, whipped jello, milk.

PUBLIC NOTICE

Public notice is hereby given that the next meeting of the Village of Kewaskum Wisconsin, Village Board is scheduled for Monday even-

DUNDEE Sand & Gravel

G. Ramthun Ph. 533-4549
Washed Sand, Crushed Gravel, Stone and Lime Chips also, GRAVEL and SAND FILL FOR THE BEST OF CONCRETE MATERIALS

ing, February 6, 1978, at 8:00 P. M. in the Council Room of the Municipal Building, 204 First Street.

Agendas for meetings are prepared as of Wednesday noon preceding the meeting and are available at the office of the clerk at the Municipal Building on Thursday preceding the meeting.

Copies of the agenda are also posted in the lobby of the Kewaskum Post Office

and in the lobby of the Valley Bank.

William Martin, Clerk

Page 11
Kewaskum Statesman
Friday, February 3, 1978

APPLES FOR SALE
At the Bridge in Kewaskum
Every Saturday 10 a. m. til Noon
Cortland — McIntosh — Delicious
Secors — Fresh Cider
CHERRY HILL FARM
BATAVIA, WI.

THE SUPER MARKET OF AUTO REPAIRS
Goeden Auto Body
Complete Auto Body Repairs and Painting Professionally Done
INSURANCE ESTIMATES AND REPAIRS OUR SPECIALTY
Automotive - Tune-Ups - Exhaust - Brakes
Tires - Anti-Freeze - Texaco Products
ALL DONE TO YOUR SATISFACTION
24 HOUR TOWING
Hy. 28 E. of Kewaskum in St. Michaels
334-2759
Try Our Personalized Service

HONECK



We have a fine selection of 1978 Chevrolet Impala's and Caprice Classics. Almost every color and option to satisfy your needs. See Orv, Paul or Mark for a great deal.



See our many new and used pickups.

YOU HAVEN'T SHOPPED UNTIL YOU'VE TRIED

HONECK CHEVROLET INC.
Hwy. 45 - Kewaskum, Wis. 53040
Phone 626-2161
Open Mon. thru Fri. 9-9; Sat. 'til 5
A Dealer You Can Trust

KEYS
MADE IN ONE MINUTE
BUY AN EXTRA KEY
Honeck Chevrolet
KEWASKUM

ROGER'S SERVICE
Mobil
people pleasers
Your Automotive Needs
With Many Years Experience
Major Tune-ups
Brakes & Mufflers
ELECTRICAL SYSTEMS
Carburetor Overhauls
SHOCKS, TIRES & BATTERIES
24 Hr. Wrecker Service
8745 Hwy. 45 So. KEWASKUM
626-2888

Uncle Ray Says:
MARKS FROM THE SCHOOL OF EXPERIENCE ARE MOSTLY BLACK AND BLUE



Enjoy good experience with your fuel oil heating - let HERRIGES OIL, INC. deliver quality low-priced fuel oil to you.

HERRIGES OIL CO.
626-2244
KEWASKUM

Meet the Men of
AUTO CRAFT



Dan Berres, Owner, West Bend
Tom Walters, West Bend
Lynn Voigt, Campbellsport
Pete Dalton, West Bend
Pat McIntee, Slinger

These trained men are dedicated to building a business on professional work, fast service and friendliness that you as our customer deserve. This is why we proudly say:

PICK YOUR BODY SHOP BEFORE WE MEET BY ACCIDENT
Take Hwy. 45 south of Kewaskum four miles to Trap Shoot Lane. (road to West Bend Sportsmen's Club) or call 338-0379



SPORTS

Indians Game At Mayville Snowed Out

Due to the blizzard conditions Thursday and Friday, Kewaskum's Friday night scheduled game at Mayville was postponed. It was re-scheduled for Tuesday, Feb. 14. All other contests in the Scenic Moraine were also cancelled.

One game was made up Saturday night with first place Kettle Moraine defeating last place Pewaukee, 51-43. Another was made up Tuesday with Slinger whipping Germantown, 74-58. The Grafton at Hartland game will be played Feb. 21.

This Friday the Indians host Hartland Arrowhead (6-2) and Tuesday they travel to Grafton (also 6-2) for two tough games.

SCENIC STANDINGS

	Won	Lost
Kettle Moraine	8	1
Hartland	6	2
Grafton	6	2
Mayville	5	3
Slinger	4	5
Kewaskum	2	6
Germantown	2	7
Pewaukee	1	8

Without Suspended Players, Kewaskum Girls Still Win

Yvonne Schacht came up with 17 points to lead the Kewaskum girls to a victory over Kettle Moraine last Tuesday to start the second round of the conference season. She had 9 of her team's 13 points in the last quarter.

Mary Ryan scored 7, Janet Matenaer and Bobbi Schmidt 5 points each to give the Indians a 4-4 Scenic record.

Kewaskum played a make-shift lineup as six varsity players and three JV's were suspended for two weeks for training violations. Coach Mike Thejler brought up three players from the JV's and Sue Russell played like she had been with the varsity all year. Sherry Strack, who had not played all year, came out to fill in for suspended players and did a good job of rebounding.

QUEEN HITS LEAGUE

	Won	Lost
Everglades	44	16
Baumann's Bus	37	23
Bauer Spraying	36	24
Dundee S. & G.	36	24
Herman's	34	24
Charles	33½	26½
Strobel's	33	27
Regal Ware	31	29
Hensen's	28	32
Fin-n-Feather	27½	32½
Johann Plumbing	27	33
Artie's Mkt.	24½	35½
Gipper's	23	37
Laurie's	23	37
Gay Nineties	21½	38½
Newsettes	21	39

Indv. high game: Renee Heberer 218, Patty Marx 205, Marion Johnson 197.

Indv. high series: Renee Heberer 529, Carol Heller 513, Lorrie Hintz 512.

Lakes Team Loses Key Game to Twins, Drops to 3rd Place

Kewaskum failed in its chance to knock off first place Thiensville-Mequon in the "B" Division Land o Lakes race here Saturday night as the Twins came out on top, 119-114, in a tight contest. A win would have moved Kewaskum to within a half game of the Twins.

Falling behind in the first quarter, 36-29, Kewaskum came back to tie it up at halftime, 56-56. Thiensville-Mequon then surged ahead in the third period (40-32) and Kewaskum closed the deficit to five points the rest of the way.

The Twins' balanced attack had 24 points by Bill Gromacki, 23 by Steve Bess and 22 each by Ken Peyer and Bill Cramer. They hit 74

Kedinger Wins Again In Snowmobile Race

Jim Kedinger and Bob Walters, both of West Bend, scored victories Saturday in Winterfest Masters competition snowmobile racing, held at the Hales Corners Speedway. Kedinger is manager of Ked-Web Sales & Service, Inc. in Kewaskum.

Kedinger, 22, who will be racing at Plymouth this next weekend, won the Stock F class race, the same event he had won at the Eagle River World Championship derby the week before. He was driving a Yamaha while Walters, driving a Mercury, won Stock B.

Page 12
Kewaskum Statesman
Friday, February 3, 1978

Kewaskum Third in JV Wrestling Meet

Pewaukee won the Scenic Moraine JV Invitational wrestling meet Saturday. The Pirates, who also have a good varsity squad, had a number of champions and many other places in scoring 148 points. Hartland was second with 106½ and Kewaskum third with 94½.

Kewaskum did quite well with two champs, two second places and two thirds with only nine competitors in the meet. The Indians had no wrestlers in unlimited, 185 or 105 lb. classes.

Soph Steve Beck (132) and junior Steve Tackes (138) received blue ribbons for first places. Freshman Bruce Rodenkirch (98) and junior Randy Dreher (112) got the second places. The third were gained by sophs Andy Strigenz (126) and Mike Pettit (155).

percent from the line. Kewaskum's Tom Zoch, Ken Loest and Clark Eichstedt tallied 37, 25 and 24 points respectively. They shot a sizzling 82.4 percent from the free throw line.

Kewaskum hosts Sussex (4-3 in the "A" Division) Saturday night at 7:30.

T-MEQUON	fg	ft	KEWASKUM	fg	ft
Zans	9	5	Loest	10	5
Peyer	10	2	Zoch	15	7
Kloehn	5	2	Eichstedt	9	6
Rogina	1	0	Backhaus	2	5
Lenke	2	0	Pieper	7	2
Raasch	3	0	Fechter	0	3
Cramer	8	6	Miller	0	0
Helvey E.	1	0	Totals	43	29
Helvey D.	1	0			
Gromacki	11	2			
Totals	51	17			
T-Mequon			36	20	23-119
Kewaskum			29	27	32-114
FM: T-Mequon 6, Kewaskum 6.					

'A' DIV.	W	L	'B' DIV.	W	L
Stingers	7	1	T-Mequon	6	2
Badgers	6	1	Hartford	5	3
Sussex	4	3	Kewaskum	4	4
Oconom.	4	4	Port Wash.	2	5
Cedarburg	0	6	Slinger	2	6
			West Bend	1	6

Pam Scannell Named to WCC All-Conference Volleyball Second Team

Four women of the volleyball team at the University of Wisconsin Center-Washington County are honored on the 1977 Wisconsin Collegiate Conference All-Conference teams.

Shelly Poler, a second year team member from West Bend West, was named to the first all-conference unit. Shelly took over as captain when the previous captain was injured in a car accident.

"Her experience helped," according to Coach Clair Bigler. "She's a good all-round player. But all my players are spikers and setters — they do both," said Bigler. Shelly will go to UW-Whitewater in the fall.

Selected to the second team was Colleen O'Connor.

"She was the best defensive player on the team, the best passer. She really involves herself in the play and is quite aggressive," Bigler notes. "Hopefully she'll be returning next year." Colleen played for two years at West Bend East and is a UWWC freshman.

Pam Scannell, Kewaskum, was also selected second team. Pam played four years at Kewaskum High School and for two years at UWWC.

"Pam sets, spikes and plays good defense," says Bigler. A sophomore, Pam will attend UW-Oshkosh in the fall.

Honorable mention went to Debbie Zimmerman,

freshman. "Debbie plays well in the front row." She played the game at West Bend West for four years.

"Though these four women made all-conference, all the team members played well and made a contribution to the team effort. Our captain Tami Regnitz would doubtless have made all-conference were it not for the injury she suffered in a car accident which made it impossible for her to play the last part of the season. We would have had a better performance in the tournament too," Bigler feels. "She was the best all-round player as well as being the tallest woman on the team, which really gave us an advantage

at the net." Tami will attend UW-Stout in fall.

UWWC ended the season with a 10-3 record. "One of those losses was to Ripon, a four-year college, and two were to unbeaten Waukesha, strongest team in the conference," according to Coach Bigler. "In the conference tournament at Waukesha, we finished in third, losing again to Waukesha in the semi-finals."

Women's sports are receiving new interest on the UWWC campus. This spring will mark the debut of the first women's basketball team. Many women from the volleyball team will also participate in basketball, to be coached by Athletic Director Tom Brigham.



THE UWWC VOLLEYBALL TEAM finished a 10-3 season recently. The women include, from kneeling front row, — Patty Kincaide, Joy Heermans, Colleen O'Connor, Therese Bury, Janice Heermans, all of West Bend.

Standing — Coach Clair Bigler, Beth Rosenthal, Debbie Figue, both of West Bend, Tami Regnitz, Cedarburg, Cathy Rose, Debbie Zimmerman, both of West Bend, Pam Scannell, Kewaskum, and Shelly Poler of West Bend.